



TSURUMI PUMP

Contractors' Pumps

Tsurumi products are distributed worldwide and renowned for their advanced technological design. For professional use.



A - Tsurumi Stuffing Box - absolutely watertight



The stuffing box is located at the cable entry section and takes the part of sealing off water. As the cable conductors consist of twisted wires, water may penetrate into the motor by the capillary phenomenon when cable sheath or insulation is damaged or when the end of the cable is submerged. The construction is such that a certain part of the insulation of each conductor is peeled and filled with rubber or epoxy resin for the complete sealing.

B - Continuous use under dry-run

Located directly above the motor windings, a snap-action self-resetting bi-metal device cuts off voltage from all three phase windings simultaneously if the current is too large in one, two or all three windings, or if the windings get too hot. Tsurumi enables measurement of winding resistance and insulation from the far end of the cable, without ever removing the cover from the motor in the field.

C - Double mechanical SiC seal in oil bath

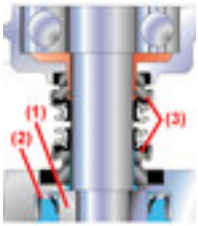

The interaction of a ring rotating with the shaft and a fixed ring, below and above an oil bath, assumes the critical role of withstanding pumping pressure and preventing water from seeping into the motor. The seals of all Tsurumi contractors' pumps, even in the 400W-class, have sealing rings of Silicon Carbide. No other material has greater hardness, selflubrication is slightly better than that of directly comparable materials. Resistance to temperature fluctuation and corrosion is also the best available.

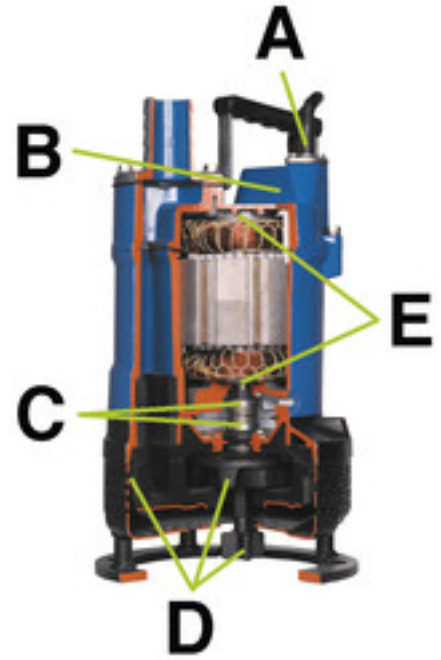

D - Increased wear resistance of pump casing and impeller

As contractors' pumps are used in unpredictable circumstances, Tsurumi has gone a long way towards making the impeller capable of the impossible and towards providing spare motor power to match. Tsurumi contractors' pumps are used extensively for bentonite mud, often with earth in the case of the models fitted with an agitator.

E - Ball bearings of highest quality

Due to the high quality of the shaft and the bear rings all pumps can be run horizontally when entirely submerged.

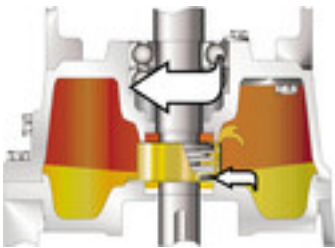

Oil Lifter

A special patented guide vane is attached inside the oil chamber. With the motor rotation oil is pumped up. Therefore even at low oil level lubrication and cooling of the mechanical seal is secured.

Top Discharge (water jacket)

Pumped water flows between the outer cover and the motor, cooling the motor and discharging as illustrated (forced motor cooling arrangement). The pump can be run continuously in air.



Top Discharge (side flow)

Pumped water cools the motor and discharges as illustrated. The motor can be cooled even when pumping a small amount of water. The top discharge arrangement allows access into areas with space limitations.



Side Discharge (spiral type)

The spiral type pump features a large waterway area as illustrated and carries sand suspensions or slurry very effectively. Since a high performance motor is used, the pump can be run continuously in air.



Water Jacket - Inner and outer motor casing - flow-through-design - perfect cooling under dry-run conditions.

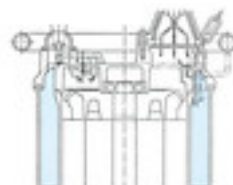

Type	Model	øDischarge bore	Motor output kW	Poles	Impeller	Level sensor	Motor protector (built-in)	Flow arrangement			
								Top discharge	Top discharge (side flow)	Side discharge (spiral type)	
Portable 1ph/230V 1ph/110V	LB	50	0,48 - 1,5	2	Vortex	○	○	○			Page 4
	HS	50 · 80	0,4 · 0,75	2	Vortex		○			○	Page 5
	HSD	50	0,55	2	Vortex		○			○	Page 5
	LSC	25	0,48	2	Vortex	○	○	○			Page 6
	NK	50 · 80	2,2	2	Vortex		○		○		Page 6
General Purpose	KTV(E)	50 · 80	0,75 - 5,5	2	Vortex	○	○		○		Page 7/8
	KTZ(E)	50 - 150	1,5 - 11,0	2	Vortex	○	○		○		Page 9/10
	KRS	100 - 250	3,0 - 22,0	4	Vortex		○	○	○		Page 11
Slurry, Bentonite	KTV2	50 · 80	2,0 · 3,0	2	Vortex		○		○		Page 12
	KTD	50 · 80	2,0 · 3,0	2	Vortex		○		○		Page 13
	KRS2	80 - 150	4,0 - 9,0	4	Vortex		○		○		Page 14
Sand	GPN	80 · 100	5,5 - 22,0	4	Vortex		○			○	Page 15
	NKZ	80 · 100	2,2 - 11,0	4	Vortex		○			○	Page 16
High Head	LH-W	50 - 100	3,0 - 110,0	2	Vortex		○	○			Page 17
	LH	100 - 200	15,0 - 110,0	2	Vortex		○	○			Page 18
	GSZ	250	75,0	4	Vortex		○			○	Page 19

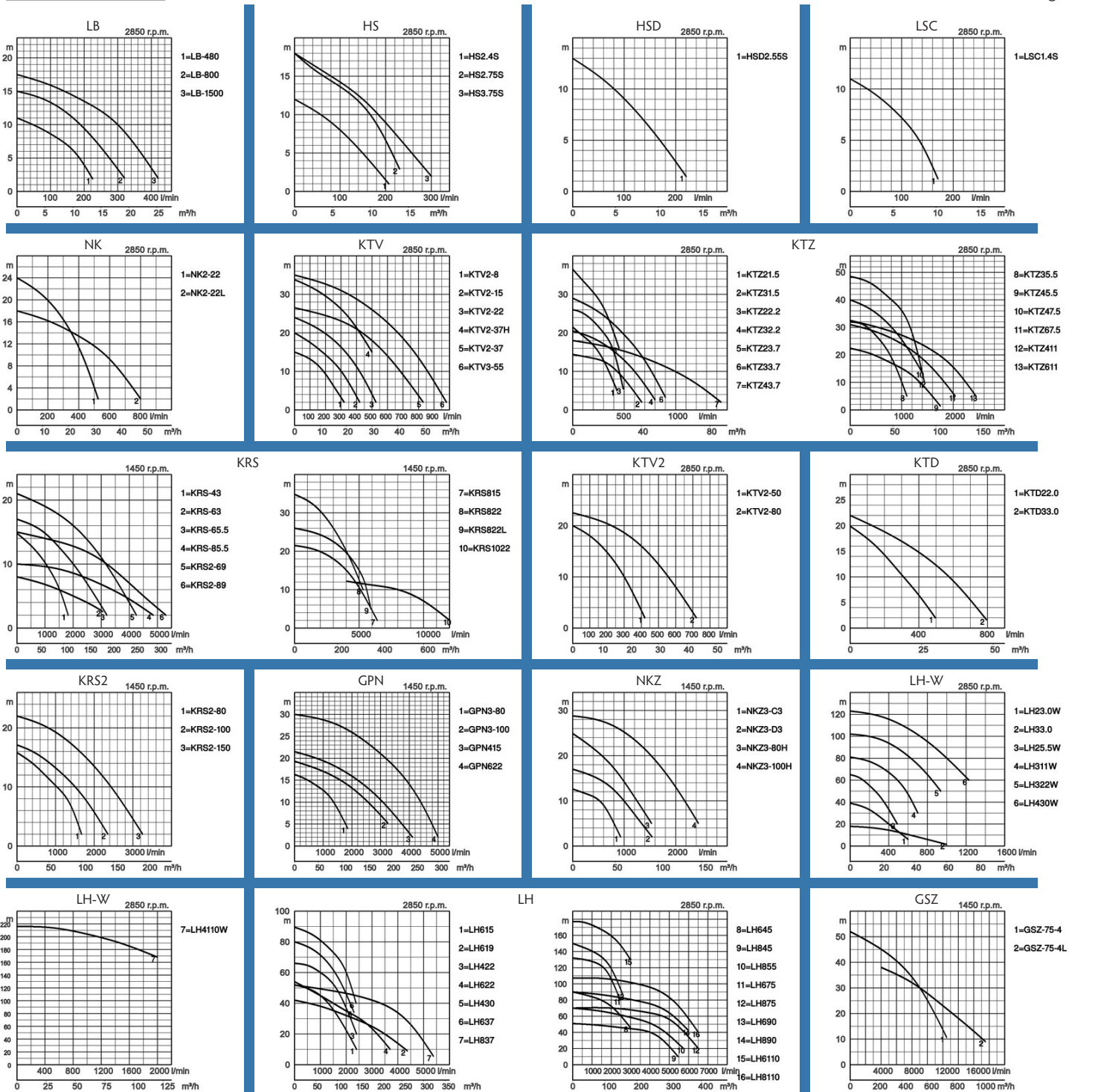

Specifications:

Model	Colour code curve	Bore mm	Motor output kW	Rated current A	Head max. m	Capacity max. l/min	Dry weight kg w/o cable	Max. solid handling ø mm	Max. water depth m	Cable length m
LB-480	1	50	0,48	2,9	11,0	225	10,4	6	10	10
LB-480A		50	0,48	2,9	11,0	225	11,0	6	10	10
LB-800	2	50	0,75	5,0	15,0	320	13,1	6	10	10
LB-800A		50	0,75	5,0	15,0	320	13,7	6	10	10
LB-1500	3	50	1,5	15,4	17,5	440	33,0	6	25	10

Light Duty Drainage Pump - LB-480A and LB-800A with level control



ø Discharge bore mm		50	
Pumping Fluid	Temperature	0-40°C	
	Type of Fluid	Spring water, Rain water, Ground water, Sand carrying water	
Pump	Components	Impeller	Semi-Vortex impeller
		Shaft Seal	Double mechanical seal
		Bearings	Shielded ball bearings
	Material	Impeller	Urethane rubber, Chromium iron casting
		Casing	Ethylene propylene rubber
		Suction Plate	Steelplate+Urethane rubber
Motor	Type, Poles	Induction motor, 2 poles, IP68	
		Lubrication	Turbine oil (ISO VG32)
	Motor Protector (built-in)	Miniature protector, Circle thermal cut-out	
	Insulation	Insulation class E, Insulation class B	
	Phase / Voltage	Single phase 230V / 110V / 50Hz	
Material	Casing	Aluminium die casting	
	Shaft	Stainless steel EN-X6Cr13	
	Cable	Rubber, H07RN-F	
Discharge Connection		Threaded flange/Hose coupling	

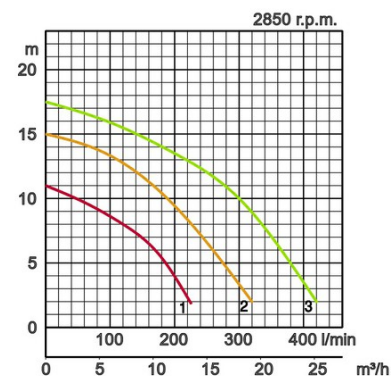

Dimensions in mm:

Model	d	A	A1	B	D	D1	H	W1
LB-480	50	187	161	353	231	-	228	50
LB-480A	50	187	161	353	231	223	228	115
LB-800	50	187	160	408	230	-	283	50
LB-800A	50	187	160	408	230	223	283	170
LB-1500	50	187	122	600	-	-	518	80

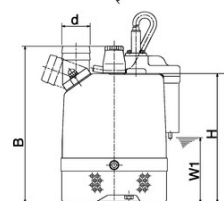
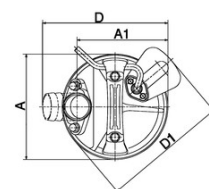

W1: lowest running water level

In the event of abrasive and corrosive utilization, stronger wear and tear will take place naturally in certain components. In this regard, please pay attention to our website www.tsurumi.eu/english/applications.htm.

Portable Contractors' Pumps

Model	Colour code curve	Bore mm	Motor output kW	Rated current A	Head max. m	Capacity max. l/min	Dry weight kg w/o cable	Max. solid handling ø mm	Max. water depth m	Cable length m	Dimensions in mm:								
											d	A	A1	B	B1	D	H	W1	
HS2.4S	●	1	50	0,4	2,6	12,2	207	11,3	7	10	10	50	240	207	158	84	185	358	90
HS2.75S	●	2	50	0,75	4,8	18,0	230	19,0	7	10	10	50	285	233	217	109	184	424	90
HS3.75S	●	3	80	0,75	4,8	18,0	300	19,6	7	10	10	80	285	233	217	109	184	424	90

The TSURUMI HS-pump is a small and robust submersible contractor's pump with a wide range of applications wherever water has to be moved.

HS

 1-phase 50Hz

Pumping Fluid	Temperature	0-40°C	
	Type of Fluid	Spring water, Rain water, Ground water, Sand carrying water	
Pump	Components	Impeller	Semi-Vortex impeller
		Shaft Seal	Double mechanical seal
		Bearings	Shielded ball bearings
	Material	Impeller	Urethane rubber
		Casing	Ductile iron casting EN-GJS-700-2
		Shaft Seal	Silicon carbide in oil bath
Motor	Type, Poles	Induction motor, 2 poles, IP68	
	Lubrication	Turbine oil (ISO VG32)	
	Motor Protector (built-in)	Miniature protector	
	Insulation	Insulation class E	
	Phase / Voltage	Single phase 230V / 110V / 50Hz	
	Material	Casing	Aluminium die casting
Shaft		Stainless steel EN-X6Cr13	
Cable		Rubber, H07RN-F	
Discharge Connection	Threaded flange/Hose coupling		

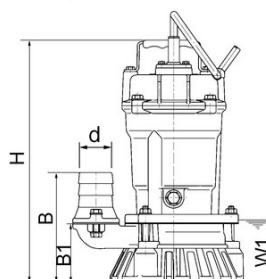
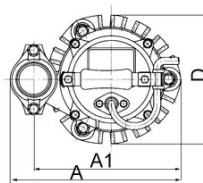

W1: lowest running water level

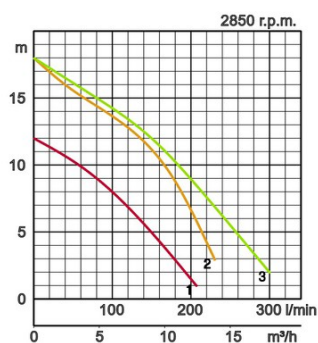

Model	Colour code curve	Bore mm	Motor output kW	Rated current A	Head max. m	Capacity max. l/min	Dry weight kg w/o cable	Max. solid handling ø mm	Max. water depth m	Cable length m	Dimensions in mm:								
											d	A	A1	B	B1	D	H	W1	
HSD2.55S	●	1	50	0,55	3,6	13,2	220	15,0	10	10	10	50	234	200	171	97	162	421	105

Portable Agitator Pump for sludge and bentonite

HSD

 1-phase 50Hz

Pumping Fluid	Temperature	0-40°C	
	Type of Fluid	Sand carrying water, Sludge, Bentonite	
Pump	Components	Impeller	Semi-Vortex impeller
		Shaft Seal	Double mechanical seal
		Bearings	Shielded ball bearings
	Material	Impeller	Chromium iron casting
		Casing	Ductile iron casting EN-GJS-700-2
		Shaft Seal	Silicon carbide in oil bath
Motor	Type, Poles	Induction motor, 2 poles, IP68	
	Lubrication	Turbine oil (ISO VG32)	
	Motor Protector (built-in)	Miniature protector	
	Insulation	Insulation class E	
	Phase / Voltage	Single phase 230V / 110V / 50Hz	
	Material	Casing	Aluminium die casting
Shaft		Stainless steel EN-X6Cr13	
Cable		Rubber, H07RN-F	
Discharge Connection	Threaded flange/Hose coupling		

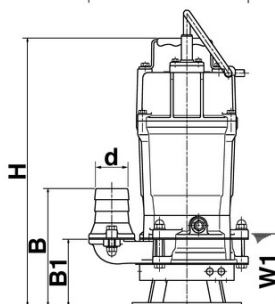
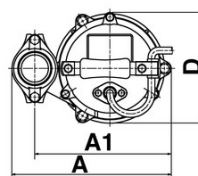

W1: lowest running water level

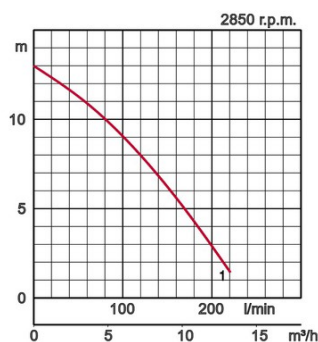

In the event of abrasive and corrosive utilization, stronger wear and tear will take place naturally in certain components. In this regard, please pay attention to our website www.tsurumi.eu/english/applications.htm.

Portable Contractors' Pumps

Model	Colour code curve	Bore mm	Motor output kW	Rated current A	Head max. m	Capacity max. l/min	Dry weight kg w/o cable	Max. solid handling ø mm	Max. water depth m	Cable length m
LSC1.4S	●	1	25	0,48	2,9	11,0	170	11,0	6	10
LSCE1.4S			25	0,48	2,9	11,0	170	11,0	6	10

Original residue dewatering pump capable of pumping down to floor level. Even the smallest puddle can be pumped dry. Ideal for complete drainage of flat surfaces where a sump is not available: rooftops, parking lots, garages, roadways, pools,...

Pumping Fluid	Temperature	0-40°C		
	Type of Fluid	Cleaning water, Water on floor, Puddles		
Pump	Components	Impeller	Semi-Vortex impeller	
		Shaft Seal	Double mechanical seal	
		Bearings	Shielded ball bearings	
	Material	Impeller	Urethane rubber	
		Casing	Ethylene propylene rubber	
		Suction Plate	Steelplate+Urethane rubber	
		Shaft Seal	Silicon carbide in oil bath	
Motor	Type, Poles	Induction motor, 2 poles, IP68		
	Lubrication	Turbine oil (ISO VG32)		
	Motor Protector (built-in)	Miniature protector		
	Insulation	Insulation class E		
	Phase / Voltage	Single phase 230V / 110V / 50Hz		
	Material	Casing	Aluminium die casting	
		Shaft	Stainless steel EN-X6Cr13	
Cable		Rubber, H07RN-F		
Discharge Connection	Hose coupling			

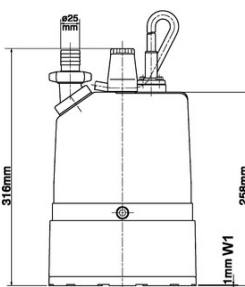
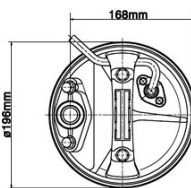

LSC1.4S-51
W1: lowest running water level

LSC 1-phase 50Hz



LSCE1.4S with level control

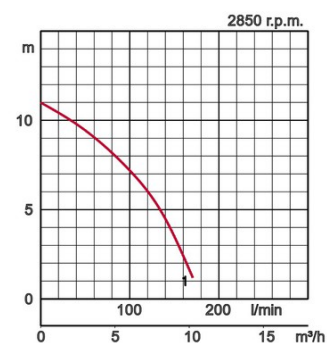

Model	Colour code curve	Bore mm	Motor output kW	Rated current A	Head max. m	Capacity max. l/min	Dry weight kg w/o cable	Max. solid handling ø mm	Max. water depth m	Cable length m	Dimensions in mm:								
											d	A	A1	B	B1	D	H	W1	
NK3-22	●	1	50	2,2	13,5	24,0	525	29,0	6	25	20	50	240	187	555	473	240	623	120
NK3-22L	●	2	80	2,2	14,5	18,0	800	40,0	6	25	20	80	235	191	601	519	216	669	120

compact - single phase - 2,2kW

Pumping Fluid	Temperature	0-40°C		
	Type of Fluid	Spring water, Rain water, Ground water, Sand carrying water		
Pump	Components	Impeller	Semi-Vortex impeller	
		Shaft Seal	Double mechanical seal	
		Bearings	Shielded ball bearings	
	Material	Impeller	Ductile iron casting EN-GJS-700-2, Chromium iron casting	
		Casing	Ethylene propylene rubber, Grey iron casting EN-GJL-200	
		Shaft Seal	Silicon carbide in oil bath	
		Motor	Type, Poles	Induction motor, 2 poles, IP68
Lubrication	Turbine oil (ISO VG32)			
Motor Protector (built-in)	Circle thermal cut-out			
Insulation	Insulation class B			
Phase / Voltage	Single phase 230V / 50Hz			
Material	Casing		Aluminium die casting	
	Shaft		Stainless steel EN-X6Cr13, Stainless steel EN-X30Cr13	
	Cable	Rubber, H07RN-F		
Discharge Connection	Threaded flange/Hose coupling			

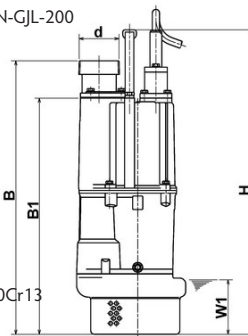
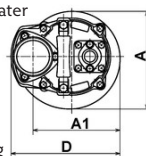

W1: lowest running water level

NK 1-phase 50Hz

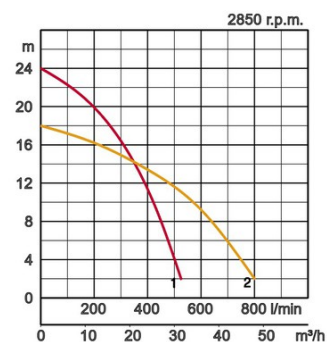

In the event of abrasive and corrosive utilization, stronger wear and tear will take place naturally in certain components. In this regard, please pay attention to our website www.tsurumi.eu/english/applications.htm.

Specifications:

Model	Colour code curve	Bore mm	Motor output kW	Rated current A	Head max. m	Capacity max. l/min	Dry weight kg w/o cable	Max. solid handling ø mm	Max. water depth m	Cable length m
KTV2-8	1	50	0,75	1,8	15,0	320	11,5	6	10	10
KTV2-15	2	50	1,5	3,3	20,0	420	20,0	8,5	25	20
KTV2-22	3	50	2,2	4,3	24,0	525	23,0	8,5	25	20
KTV2-37H	4	50	3,7	7,4	33,8	500	36,0	8,5	25	20
KTV2-37	5	80	3,7	7,4	26,5	830	36,0	8,5	25	20
KTV3-55	6	80	5,5	11,0	35,0	980	47,0	8,5	25	20



Light but wear resistant

The KTV-series combines high tech materials for maximum durability, yet lightweight and portable.

Discharge bore mm	50, 80		
Pumping Fluid	Temperature	0-40°C	
	Type of Fluid	Spring water, Rain water, Ground water, Sand carrying water	
Pump	Components	Impeller	Semi-Vortex impeller
		Shaft Seal	Double mechanical seal
		Bearings	Shielded ball bearings
	Material	Impeller	Urethane rubber, Ductile iron casting EN-GJS-700-2
		Casing	Synthetic rupper
Shaft Seal	Silicon carbide in oil bath		
Motor	Type, Poles	Induction motor, 2 poles, IP68	
	Lubrication	Turbine oil (ISO VG32)	
	Motor Protector (built-in)	Circle thermal cut-out	
	Insulation	Insulation class E	
	Phase / Voltage	3-phase / 400V / 50Hz / d.o.l.	
	Material	Casing	Aluminium die casting
Shaft		Stainless steel EN-X30Cr13, Stainless steel EN-X6Cr13	
Cable		Rubber, H07RN-F	
Discharge Connection	Threaded flange/Hose coupling		

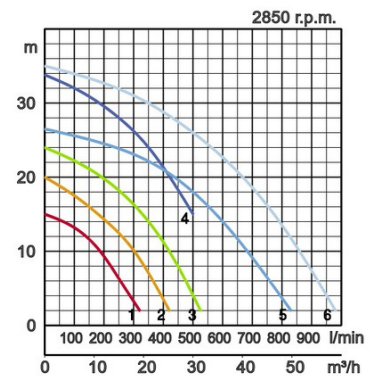

Dimensions in mm:

Model	A	A1	B	B1	D	H	W1
KTV2-8	200	155	353	281	200	369	65
KTV2-15	240	187	392	310	240	396	80
KTV2-22	240	187	412	330	240	416	80
KTV2-37H	285	211	510	387	285	510	90
KTV2-37	285	211	510	387	285	510	90
KTV3-55	300	229	545	422	300	545	90

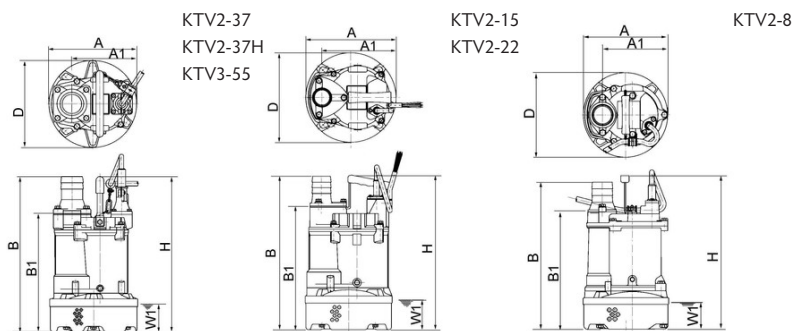

W1: lowest running water level

In the event of abrasive and corrosive utilization, stronger wear and tear will take place naturally in certain components. In this regard, please pay attention to our website www.tsurumi.eu/english/applications.htm.

Specifications:

Model	Colour code curve	Bore mm	Motor output kW	Rated current A	Head max. m	Capacity max. l/min	Dry weight kg w/o cable	Max. solid handling ø mm	Max. water depth m	Cable length m
KTVE2.75	1	50	0,75	1,8	15,0	320	12,7	6	10	10
KTVE21.5	2	50	1,5	3,3	20,0	420	22,0	8,5	25	20
KTVE22.2	3	50	2,2	4,3	24,0	525	25,0	8,5	25	20
KTVE33.7	4	80	3,7	7,4	26,5	830	40,0	8,5	25	20
KTVE35.5	5	80	5,5	11,0	35,0	980	52,0	8,5	25	20



Electrode Auto Control System

The KTVE-type is equipped with a new electrode type control system.

Pump operation is started when the water level rises and contacts the electrode.

When the the water-electrode contact is lost the timer starts operating, after one minute pump operation is stopped.

ø Discharge bore mm	50, 80		
Pumping Fluid	Temperature	0-40°C	
	Type of Fluid	Spring water, Rain water, Ground water, Sand carrying water	
Pump	Components	Impeller	Semi-Vortex impeller
		Shaft Seal	Double mechanical seal
		Bearings	Shielded ball bearings
	Material	Impeller	Urethane rubber, Ductile iron casting EN-GJS-700-2
		Casing	Synthetic rupper
Shaft Seal	Silicon carbide in oil bath		
Motor	Type, Poles	Induction motor, 2 poles, IP68	
	Lubrication	Turbine oil (ISO VG32)	
	Motor Protector (built-in)	Circle thermal cut-out	
	Insulation	Insulation class E	
	Phase / Voltage	3-phase / 400V / 50Hz / d.o.l.	
	Material	Casing	Aluminium die casting
Shaft		Stainless steel EN-X30Cr13, Stainless steel EN-X6Cr13	
Cable		Rubber, H07RN-F, Rubber, NSSHÖU	
Discharge Connection	Threaded flange/Hose coupling		

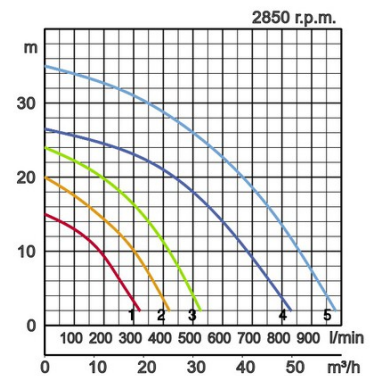

Dimensions in mm:

Model	A	A1	B	B1	D	H	W1
KTVE2.75	200	155	401	329	200	417	234
KTVE21.5	240	187	482	400	240	486	265
KTVE22.2	240	187	482	400	240	486	265
KTVE33.7	285	211	585	462	285	585	327
KTVE35.5	-	229	620	497	300	620	357

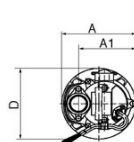

KTVE2.75

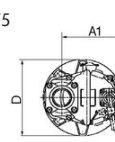

KTVE35.5

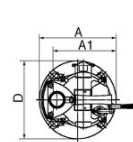

KTVE21.5

KTVE22.2

KTVE33.7

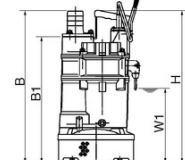
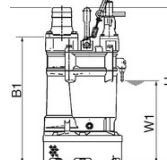
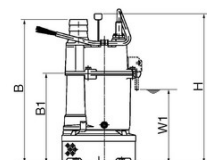

W1: lowest running water level

In the event of abrasive and corrosive utilization, stronger wear and tear will take place naturally in certain components. In this regard, please pay attention to our website www.tsurumi.eu/english/applications.htm.

Specifications:

Model	Colour code curve	Bore mm	Motor output kW	Rated current A	Head max. m	Capacity max. l/min	Dry weight kg w/o cable	Max. solid handling ø mm	Max. water depth m	Cable length m
KTZ21.5	1	50	1,5	3,5	21,5	430	30,0	8,5	25	20
KTZ31.5	2	80	1,5	3,5	14,4	670	30,0	8,5	25	20
KTZ22.2	3	50	2,2	5,0	26,0	500	34,0	8,5	25	20
KTZ32.2	4	80	2,2	5,0	20,5	800	34,0	8,5	25	20
KTZ23.7	5	50	3,7	7,7	36,5	450	63,0	8,5	25	20
KTZ33.7	6	80	3,7	7,7	29,0	900	63,0	8,5	25	20
KTZ43.7	7	100	3,7	7,7	18,0	1440	63,0	8,5	25	20
KTZ35.5	8	80	5,5	11,4	32,0	1100	73,0	8,5	25	20
KTZ45.5	9	100	5,5	11,4	22,5	1740	73,0	8,5	25	20
KTZ47.5	10	100	7,5	15,0	40,0	1400	100,0	12	25	20
KTZ67.5	11	150	7,5	15,0	31,0	2030	99,0	20	25	20
KTZ411	12	100	11,0	22,0	48,5	1440	130,0	12	25	20
KTZ611	13	150	11,0	22,0	32,5	2440	131,0	20	25	20



Standard Submersible Drainage Pump generally applicable

ø Discharge bore mm		50, 80, 100, 150	
Pumping Fluid	Temperature	0-40°C	
	Type of Fluid	Spring water, Rain water, Ground water, Sand carrying water	
Pump	Components	Impeller	Semi-open type impeller
		Shaft Seal	Double mechanical seal
		Bearings	Shielded ball bearings
	Material	Impeller	Chromium iron casting
		Casing	Grey iron casting EN-GJL-200
		Suction Plate	Ductile iron casting EN-GJS-500-7
	Shaft Seal	Silicon carbide in oil bath	
Motor	Type, Poles	Induction motor, 2 poles, IP68	
	Lubrication	Turbine oil (ISO VG32)	
	Motor Protector (built-in)	Circle thermal cut-out	
	Insulation	Insulation class F	
	Phase / Voltage	3-phase / 400V / 50Hz / d.o.l.	
	Material	Casing	Grey iron casting EN-GJL-200
Shaft		Stainless steel EN-X30Cr13	
Cable		Rubber, H07RN-F	
Discharge Connection		Threaded flange/Hose coupling	

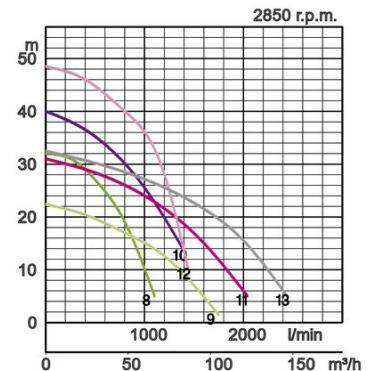
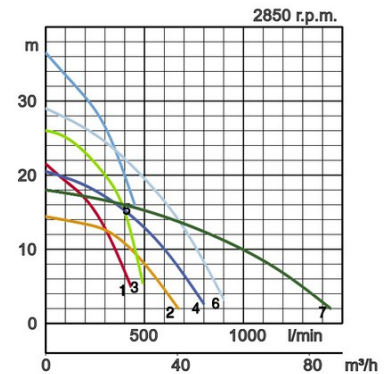

Dimensions in mm:

Model	A	A1	B	B1	D	H	W1
KTZ21.5	235	173	509	401	216	478	120
KTZ31.5	235	173	509	401	216	478	120
KTZ22.2	235	173	529	421	216	498	120
KTZ32.2	235	173	529	421	216	498	120
KTZ23.7	283	208	627	504	252	637	150
KTZ33.7	283	208	627	504	252	637	150
KTZ43.7	283	208	642	504	252	637	150
KTZ35.5	306	218	671	548	259	688	150
KTZ45.5	306	218	686	548	259	688	150
KTZ47.5	330	240	764	626	314	687	190
KTZ67.5	330	240	799	626	314	687	190
KTZ411	373	260	806	645	350	740	190
KTZ611	373	260	826	645	350	740	190

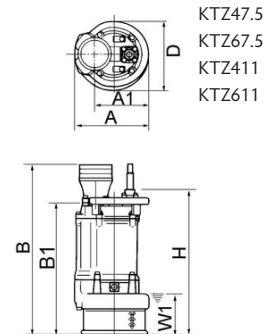
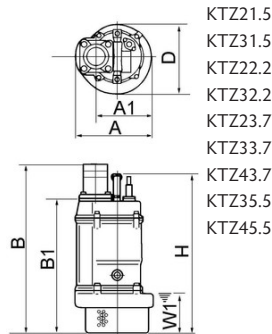

W1: lowest running water level

In the event of abrasive and corrosive utilization, stronger wear and tear will take place naturally in certain components. In this regard, please pay attention to our website www.tsurumi.eu/english/applications.htm.

Specifications:

Model	Colour code curve	Bore mm	Motor output kW	Rated current A	Head max. m	Capacity max. l/min	Dry weight kg w/o cable	Max. solid handling ø mm	Max. water depth m	Cable length m
KTZE21.5	1	50	1,5	3,5	21,5	430	40,0	8,5	25	20
KTZE31.5	2	80	1,5	3,5	14,4	670	39,0	8,5	25	20
KTZE22.2	3	50	2,2	5,0	26,0	500	42,0	8,5	25	20
KTZE32.2	4	80	2,2	5,0	20,4	800	41,0	8,5	25	20
KTZE23.7	5	50	3,7	7,7	36,5	450	71,0	8,5	25	20
KTZE33.7	6	80	3,7	7,7	29,0	900	71,0	8,5	25	20
KTZE43.7	7	100	3,7	7,7	18,0	1440	71,0	8,5	25	20



Electrode Auto Control System

The KTZE-type is equipped with a new electrode type control system.

Pump operation is started when the water level rises and contacts the electrode.

When the the water-electrode contact is lost the timer starts operating, after one minute pump operation is stopped.

ø Discharge bore mm		50, 80, 100		
Pumping Fluid	Temperature	0-40°C		
	Type of Fluid	Spring water, Rain water, Ground water, Sand carrying water		
Pump	Components	Impeller	Semi-open type impeller	
		Shaft Seal	Double mechanical seal	
		Bearings	Shielded ball bearings	
	Material	Impeller	Chromium iron casting	
		Casing	Grey iron casting EN-GJL-200	
		Suction Plate	Ductile iron casting EN-GJS-500-7	
		Shaft Seal	Silicon carbide in oil bath	
Motor	Type, Poles	Induction motor, 2 poles, IP68		
	Lubrication	Turbine oil (ISO VG32)		
	Motor Protector (built-in)	Circle thermal cut-out		
	Insulation	Insulation class F		
	Phase / Voltage	3-phase / 400V / 50Hz / d.o.l.		
	Material	Casing	Grey iron casting EN-GJL-200	
		Shaft	Stainless steel EN-X30Cr13	
Cable		Rubber, NSSHÖU		
Discharge Connection		Threaded flange/Hose coupling		

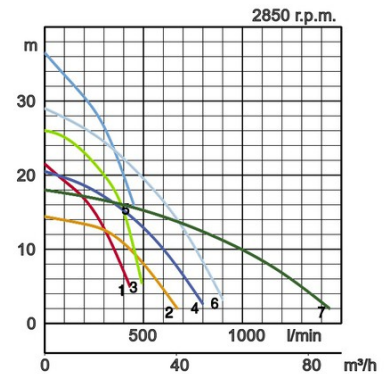

Dimensions in mm:

Model	A	A1	B	D	H	W1
KTZE21.5	261	235	609	216	728	345
KTZE31.5	268	235	609	216	728	345
KTZE22.2	261	235	629	216	748	355
KTZE32.2	268	235	629	216	748	355
KTZE23.7	338	283	747	252	717	435
KTZE33.7	353	283	757	252	717	435
KTZE43.7	368	283	767	252	717	435

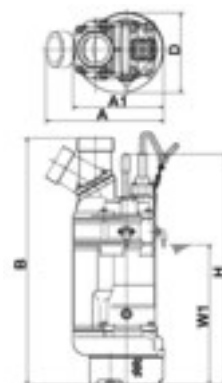

W1: lowest running water level

In the event of abrasive and corrosive utilization, stronger wear and tear will take place naturally in certain components. In this regard, please pay attention to our website www.tsurumi.eu/english/applications.htm.

Specifications:

Model	Colour code curve	Bore mm	Motor output kW	Rated current A	Head max. m	Capacity max. l/min	Dry weight kg w/o cable	Max. solid handling ø mm	Max. water depth m	Cable length m
KRS-43	1	100	3,0	6,5	14,8	1820	95,0	12	15	20
KRS-63	2	150	3,0	6,5	8,0	3250	97,0	15	15	20
KRS-65.5	3	150	5,5	12,1	17,0	3180	118,0	20	15	20
KRS-85.5	4	200	5,5	12,1	10,0	4850	118,0	20	15	20
KRS2-69	5	150	9,0	19,0	21,0	4250	155,0	20	15	20
KRS2-89	6	200	9,0	19,0	15,0	5300	175,0	30	15	20
KRS815	7	200	15,0	31,9	21,5	6400	240,0	25	20	20
KRS822	8	200	22,0	44,6	34,8	5300	380,0	25	20	20
KRS822L	9	200	22,0	44,6	26,0	5900	390,0	25	20	20
KRS1022	10	250	22,0	45,7	12,1	12000	390,0	25	20	20



Heavy Duty Dewatering Pump
4-pole motor - excellent durability

ø Discharge bore mm		100, 150, 200, 250		
Pumping Fluid	Temperature	0-40°C		
	Type of Fluid	Spring water, Rain water, Ground water, Sand carrying water		
Pump	Components	Impeller	Semi-open type impeller, Closed type impeller	
		Shaft Seal	Double mechanical seal	
		Bearings	Shielded ball bearings	
	Material	Impeller	Ductile iron casting EN-GJS-700-2	
		Casing	Grey iron casting EN-GJL-200	
		Suction Plate	Grey iron casting EN-GJL-200	
	Shaft Seal	Silicon carbide in oil bath		
Motor	Type, Poles	Induction motor, 4 poles, IP68		
	Lubrication	Turbine oil (ISO VG32)		
	Motor Protector (built-in)	Circle thermal cut-out		
	Insulation	Insulation class E, Insulation class F, Insulation class B		
	Phase / Voltage	3-phase / 400V / 50Hz / d.o.l.		
	Material	Casing	Grey iron casting EN-GJL-150, Grey iron casting EN-GJL-200	
Shaft		Stainless steel EN-X30Cr13		
Cable		Rubber, H07RN-F, Rubber, NSSHÖU		
Discharge Connection		Threaded flange, Hose coupling		

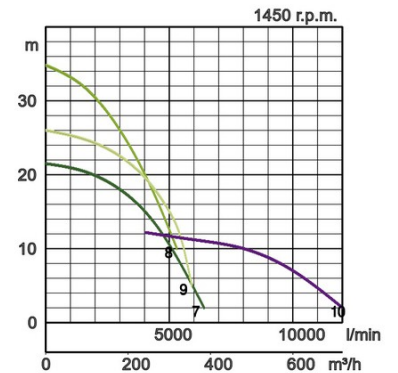
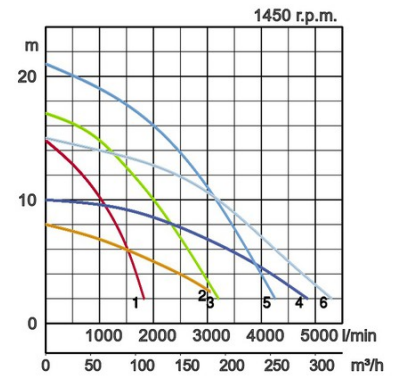

Dimensions in mm:

Model	A	A1	B	B1	D	H	W1
KRS-43	378	288	723	586	347	651	170
KRS-63	385	295	867	686	365	777	300
KRS-65.5	423	303	790	608	369	698	190
KRS-85.5	445	325	942	710	413	800	295
KRS2-69	487	371	812	630	424	743	200
KRS2-89	470	354	933	701	403	814	300
KRS815	481	347	1069	837	440	949	275
KRS822	572	445	1238	1006	530	1156	345
KRS822L	572	445	1238	1006	530	1156	345
KRS1022	525	260	1419	1156	-	-	450

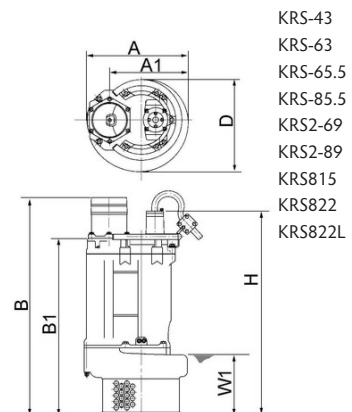
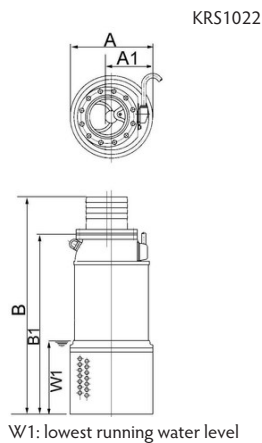

In the event of abrasive and corrosive utilization, stronger wear and tear will take place naturally in certain components. In this regard, please pay attention to our website www.tsurumi.eu/english/applications.htm.

Specifications:

Model	Colour code curve	Bore mm	Motor output kW	Rated current A	Head max. m	Capacity max. l/min	Dry weight kg w/o cable	Max. solid handling ø mm	Max. water depth m	Cable length m
KTV2-50	● 1	50	2,0	3,8	20,0	420	25,0	10	25	20
KTV2-80	● 2	80	3,0	6,1	22,5	720	38,0	10	25	20

Light Weight Bentonite Pump

A powerful slurry pump using KTV pumps as a base. Features wear resistance, durability and extra light weight.



ø Discharge bore mm		50, 80	
Pumping Fluid	Temperature	0-40°C	
	Type of Fluid	Sludge, Slurry, Liquids containing mud	
Pump	Components	Impeller	Semi-Vortex impeller
		Shaft Seal	Double mechanical seal
		Bearings	Shielded ball bearings
	Material	Impeller	Chromium iron casting
		Casing	Synthetic rubber
		Shaft Seal	Silicon carbide in oil bath
Motor	Type, Poles	Induction motor, 2 poles, IP68	
	Lubrication	Turbine oil (ISO VG32)	
	Motor Protector (built-in)	Circle thermal cut-out	
	Insulation	Insulation class E	
	Phase / Voltage	3-phase / 400V / 50Hz / d.o.l.	
	Material	Casing	Aluminium die casting
Shaft		Stainless steel EN-X6Cr13	
Cable		Rubber, H07RN-F	
Discharge Connection		Threaded flange/Hose coupling	

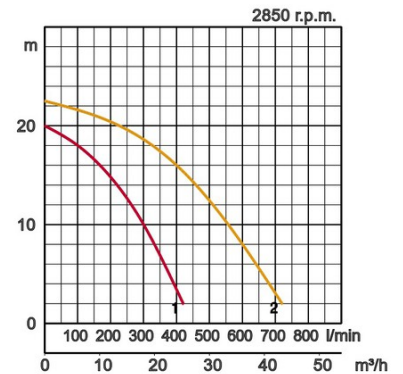

Dimensions in mm:

Model	A	A1	B	B1	D	H	W1
KTV2-50	250	192	450	368	250	454	120
KTV2-80	295	216	550	427	295	550	130

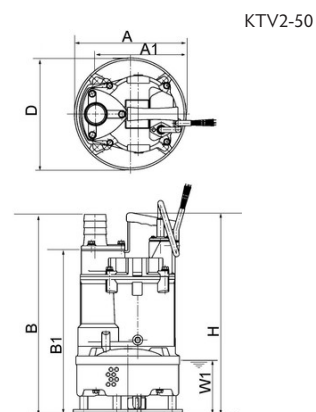
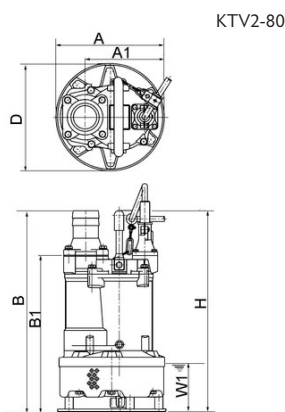

W1: lowest running water level

In the event of abrasive and corrosive utilization, stronger wear and tear will take place naturally in certain components. In this regard, please pay attention to our website www.tsurumi.eu/english/applications.htm.

Specifications:

Model	Colour code curve	Bore mm	Motor output kW	Rated current A	Head max. m	Capacity max. l/min	Dry weight kg w/o cable	Max. solid handling ø mm	Max. water depth m	Cable length m
KTD22.0	1	50	2,0	4,5	19,9	496	38,0	8,5	25	20
KTD33.0	2	80	3,0	6,5	22,0	794	65,0	8,5	25	20

A powerful slurry pump using KTZ pumps as a base. Features wear resistance and durability.



ø Discharge bore mm		50, 80		
Pumping Fluid	Temperature	0-40°C		
	Type of Fluid	Sludge, Slurry, Liquids containing sandy mud and/or bentonite		
Pump	Components	Impeller	Semi-open type impeller	
		Shaft Seal	Double mechanical seal	
		Bearings	Shielded ball bearings	
	Material	Impeller	Chromium iron casting	
		Casing	Grey iron casting EN-GJL-200	
		Suction Plate	Ductile iron casting EN-GJS-500-7	
		Shaft Seal	Silicon carbide in oil bath	
Motor	Type, Poles		Induction motor, 2 poles, IP68	
	Lubrication		Turbine oil (ISO VG32)	
	Motor Protector (built-in)		Circle thermal cut-out	
	Insulation		Insulation class F	
	Phase / Voltage		3-phase / 400V / 50Hz / d.o.l.	
	Material	Casing	Grey iron casting EN-GJL-200	
		Shaft	Stainless steel EN-X30Cr13	
Cable		Rubber, NSSHÖU		
Discharge Connection		Threaded flange/Hose coupling		

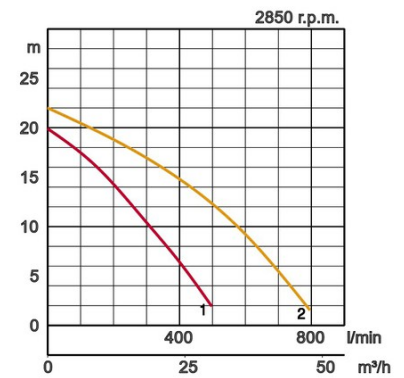

Dimensions in mm:

Model	A	A1	B	B1	D	H	W1
KTD22.0	235	173	550	442	221	519	140
KTD33.0	297	222	644	521	266	654	160

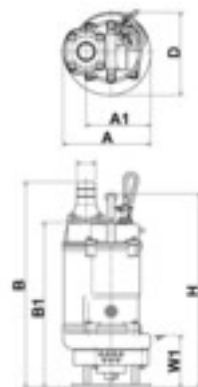

W1: lowest running water level

In the event of abrasive and corrosive utilization, stronger wear and tear will take place naturally in certain components. In this regard, please pay attention to our website www.tsurumi.eu/english/applications.htm.

Specifications:

Model	Colour code curve	Bore mm	Motor output kW	Rated current A	Head max. m	Capacity max. l/min	Dry weight kg w/o cable	Max. solid handling ø mm	Max. water depth m	Cable length m
KRS2-80	1	80	4,0	9,5	15,8	1670	105,0	30	15	20
KRS2-100	2	100	6,0	13,0	17,1	2350	145,0	30	15	20
KRS2-150	3	150	9,0	18,5	22,0	3250	170,0	30	15	20

Heavy Duty Slurry Pump

Tsurumi's typical slurry pumps with a 4-pole motor for an increased lifetime and greater convenience.



ø Discharge bore mm		80, 100, 150		
Pumping Fluid	Temperature	0-40°C		
	Type of Fluid	Sludge, Slurry, Liquids containing sandy mud and/or bentonite		
Pump	Components	Impeller	Open type impeller	
		Shaft Seal	Double mechanical seal	
		Bearings	Shielded ball bearings	
	Material	Impeller	Chromium iron casting	
		Casing	Grey iron casting EN-GJL-200	
		Suction Plate	Chromium iron casting	
		Shaft Seal	Silicon carbide in oil bath	
Motor	Type, Poles		Induction motor, 4 poles, IP68	
	Lubrication		Turbine oil (ISO VG32)	
	Motor Protector (built-in)		Circle thermal cut-out	
	Insulation		Insulation class E, Insulation class B	
	Phase / Voltage		3-phase / 400V / 50Hz / d.o.l.	
	Material	Casing	Grey iron casting EN-GJL-150	
		Shaft	Stainless steel EN-X30Cr13	
Cable		Rubber, H07RN-F		
Discharge Connection		Threaded flange/Hose coupling		

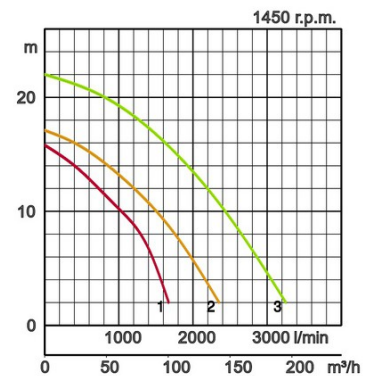

Dimensions in mm:

Model	A	A1	B	B1	D	H	W1
KRS2-80	350	260	786	666	326	766	250
KRS2-100	415	305	816	678	374	754	250
KRS2-150	434	324	879	699	407	811	250

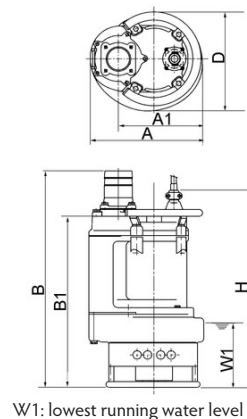

In the event of abrasive and corrosive utilization, stronger wear and tear will take place naturally in certain components. In this regard, please pay attention to our website www.tsurumi.eu/english/applications.htm.

Specifications:

Model	Colour code curve	Bore mm	Motor output kW	Rated current A	Head max. m	Capacity max. l/min	Dry weight kg w/o cable	Max. solid handling ø mm	Max. water depth m	Cable length m
GPN35.5	1	80	5,5	12,1	16,3	1900	145,0	30	20	20
GPN411	2	100	11,0	22,0	19,3	3250	217,0	30	20	20
GPN415	3	100	15,0	25,8	21,5	4110	220,0	30	20	20
GPN622	4	150	22,0	42,5	30,0	5000	415,0	30	20	20

Heavy Duty Sand Pump

A special steel impeller and suction plate have greatly increased the pump's life. The casing is designed to have wide passing area, thorough thickness and anti-abrasion material.



ø Discharge bore mm		80, 100, 150		
Pumping Fluid	Temperature	0-40°C		
	Type of Fluid	Sludge, Slurry, Liquids containing sandy mud and/or bentonite		
Pump	Components	Impeller	Open type impeller	
		Shaft Seal	Double mechanical seal	
		Bearings	Shielded ball bearings	
	Material	Impeller	Chromium iron casting	
		Casing	Grey iron casting EN-GJL-200	
		Suction Plate	Chromium iron casting	
		Shaft Seal	Silicon carbide in oil bath	
Motor	Type, Poles		Induction motor, 4 poles, IP68	
	Lubrication		Turbine oil (ISO VG32)	
	Motor Protector (built-in)		Circle thermal cut-out	
	Insulation		Insulation class E, Insulation class B	
	Phase / Voltage		3-phase / 400V / 50Hz / d.o.l.	
	Material	Casing	Grey iron casting EN-GJL-150	
		Shaft	Chromium-molybdenum steel (DIN 1.7220)	
Cable		Rubber, H07RN-F, Rubber, NSSHÖU		
Discharge Connection		Threaded flange/Hose coupling		

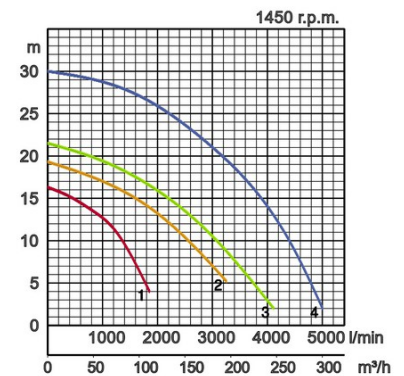

Dimensions in mm:

Model	A	A1	B	B1	D	H	W1
GPN35.5	487	426	429	307	390	777	270
GPN411	617	517	481	328	450	860	295
GPN415	617	518	481	328	451	860	295
GPN622	725	625	528	335	572	1102	300

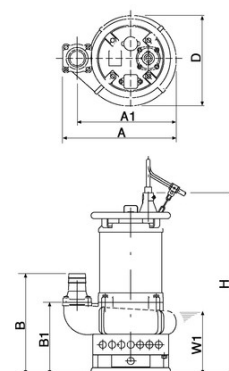

W1: lowest running water level

In the event of abrasive and corrosive utilization, stronger wear and tear will take place naturally in certain components. In this regard, please pay attention to our website www.tsurumi.eu/english/applications.htm.

Specifications:

Model	Colour code curve	Bore mm	Motor output kW	Rated current A	Head max. m	Capacity max. l/min	Dry weight kg w/o cable	Max. solid handling ø mm	Max. water depth m	Cable length m
NKZ3-C3	1	80	2,2	5,1	12,6	930	91,0	30	15	20
NKZ3-D3	2	80	3,7	8,0	17,0	1540	100,0	30	15	20
NKZ3-80H	3	80	5,5	12,1	24,9	1530	132,0	20	15	20
NKZ3-100H	4	100	11,0	22,0	28,8	2440	196,0	20	15	20

All Purpose Sand Pumps

All pumps in this series provide very smooth passage of sandy earth and slime. A forcibly cooled motor ensures long and continuous pump operations exposed to the air.



ø Discharge bore mm		80, 100		
Pumping Fluid	Temperature	0-40°C		
	Type of Fluid	Liquids containing sandy mud, Sand carrying water		
Pump	Components	Impeller	Open type impeller	
		Shaft Seal	Double mechanical seal	
		Bearings	Shielded ball bearings	
	Material	Impeller	Ductile iron casting EN-GJS-700-2, Chromium iron casting	
		Casing	Grey iron casting EN-GJL-200	
		Suction Plate	Grey iron casting EN-GJL-200, Ductile iron casting EN-GJS-700-2	
		Shaft Seal	Silicon carbide in oil bath	
Motor	Type, Poles	Induction motor, 4 poles, IP68		
	Lubrication	Turbine oil (ISO VG32)		
	Motor Protector (built-in)	Circle thermal cut-out		
	Insulation	Insulation class E, Insulation class B		
	Phase / Voltage	3-phase / 400V / 50Hz / d.o.l.		
	Material	Casing	Grey iron casting EN-GJL-150	
		Shaft	Stainless steel EN-X30Cr13	
Cable		Rubber, H07RN-F		
Discharge Connection		Threaded flange/Hose coupling		

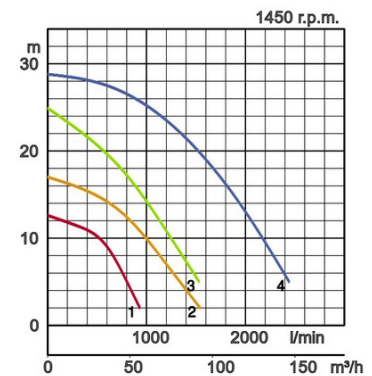

Dimensions in mm:

Model	d	A	A1	B	B1	D	H	W1
NKZ3-C3	80	467	405	371	249	370	664	225
NKZ3-D3	80	467	405	371	249	370	664	225
NKZ3-80H	80	491	430	387	264	401	754	220
NKZ3-100H	100	547	486	422	284	414	841	240

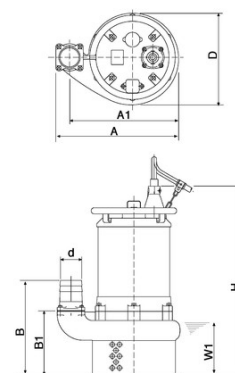

W1: lowest running water level

In the event of abrasive and corrosive utilization, stronger wear and tear will take place naturally in certain components. In this regard, please pay attention to our website www.tsurumi.eu/english/applications.htm.

Specifications:

Model	Colour code curve	Bore mm	Motor output kW	Rated current A	Head max. m	Capacity max. l/min	Dry weight kg w/o cable	Max. solid handling ø mm	Max. water depth m	Cable length m
LH23.0W	1	50	3,0	6,5	39,0	600	46,0	6	25	20
LH33.0	2	80	3,0	6,5	18,0	1000	42,0	6	25	20
LH25.5W	3	50	5,5	11,0	65,0	490	80,0	6	30	20
LH311W	4	80	11,0	22,0	81,0	700	130,0	8,5	30	20
LH322W	5	80	22,0	39,0	102,0	940	304,0	8,5	30	20
LH430W	6	100	30,0	53,0	123,0	940	324,0	8,5	30	20
LH4110W	7	100	110,0	209,0	216,0	2000	1270,0	8,0	30	20

High Head Pumps - Slim Design

High water pressure resistance (30m H2O). Top discharge with center flange, efficient cooling by water jacket.



ø Discharge bore mm		50, 80, 100	
Pumping Fluid	Temperature	0-40°C	
	Type of Fluid	Spring water, Rain water, Ground water, Sand carrying water	
Pump	Components	Impeller	Closed type impeller
		Shaft Seal	Double mechanical seal
		Bearings	Shielded ball bearings
	Material	Impeller	Chromium iron casting
		Shaft Seal	Silicon carbide in oil bath
		Casing	Grey iron casting EN-GJL-200, Ductile iron casting EN-GJS-450-10
Motor	Type, Poles		Induction motor, 2 poles, IP68
	Lubrication		Turbine oil (ISO VG32)
	Motor Protector (built-in)		Circle thermal cut-out, Miniature protector
	Insulation		Insulation class F, Insulation class B
	Phase / Voltage		3-phase / 400V / 50Hz / d.o.l.
	Material	Casing	Grey iron casting EN-GJL-200
Shaft		Stainless steel EN-X30Cr13	
Cable		Rubber, H07RN-F, Rubber, NSSHÖU	
Discharge Connection		Threaded flange, JIS 20K Flange	

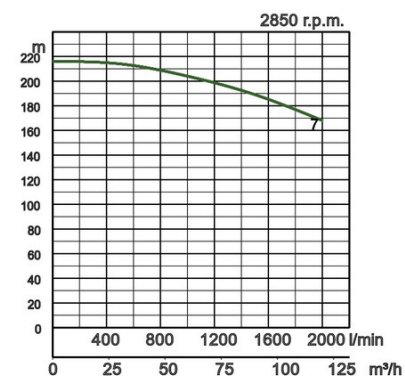
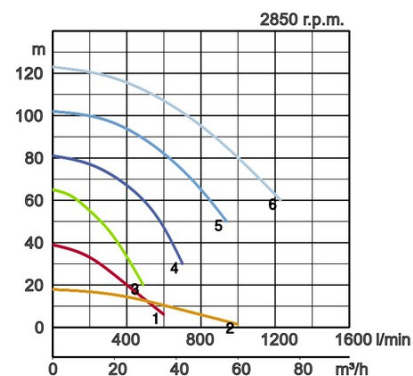

Dimensions in mm:

Model	d	B	D	D1	W1
LH23.0W	50	591	185	-	150
LH33.0	80	591	185	-	150
LH25.5W	50	750	240	-	170
LH311W	80	1030	270	-	200
LH322W	80	1234	330	-	300
LH430W	100	1375	330	-	300
LH4110W	100	1825	616	592	380

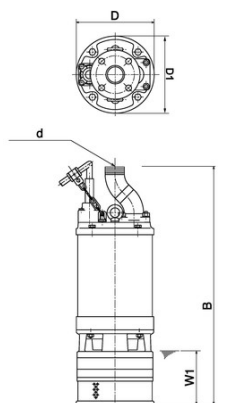

W1: lowest running water level

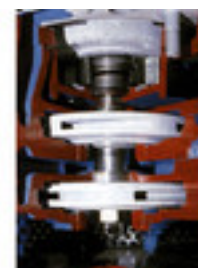

In the event of abrasive and corrosive utilization, stronger wear and tear will take place naturally in certain components. In this regard, please pay attention to our website www.tsurumi.eu/english/applications.htm.

Specifications:

Model	Colour code curve	Bore mm	Motor output kW	Rated current A	Head max. m	Capacity max. l/min	Dry weight kg w/o cable	Max. solid handling ø mm	Max. water depth m	Cable length m
LH615	1	150	15,0	27,5	52,0	2400	213,0	8,5	30	20
LH619	2	150	19,0	36,0	42,0	4370	350,0	12	30	20
LH422	3	100	22,0	40,5	66,0	2400	350,0	6	30	20
LH622	4	150	22,0	40,5	54,0	3750	360,0	12	30	20
LH430	5	100	30,0	55,0	80,0	2300	355,0	6	30	20
LH637	6	150	37,0	67,0	89,5	2380	495,0	6	30	20
LH837	7	200	37,0	67,0	51,8	5375	495,0	20	30	20
LH645	8	150	45,0	81,0	90,0	2975	510,0	6	30	20
LH845	9	200	45,0	81,0	50,8	5450	510,0	20	30	20
LH855	10	200	55,0	100,0	70,0	5725	820,0	20	30	20
LH675	11	150	75,0	130,0	132,0	2450	865,0	6	30	20
LH875	12	200	75,0	130,0	70,0	6500	865,0	20	30	20
LH690	13	150	90,0	166,0	150,0	2500	1100,0	6	30	20
LH890	14	200	90,0	166,0	90,0	6000	1150,0	20	30	20
LH6110	15	150	110,0	209,0	177,0	3000	1210,0	6	30	20
LH8110	16	200	110,0	209,0	107,0	6500	1210,0	20	30	20



High Head Pumps - Deep Well Draining

Discharge bore mm		100, 150, 200	
Pumping Fluid	Temperature	0-40°C	
	Type of Fluid	Spring water, Rain water, Ground water, Sand carrying water	
Pump	Components	Impeller	Closed type impeller
		Shaft Seal	Double mechanical seal
		Bearings	Shielded ball bearings
	Material	Impeller	Chromium iron casting
		Casing	Ductile iron casting EN-GJS-450-10, Grey iron casting EN-GJL-200
	Shaft Seal	Silicon carbide in oil bath	
Motor	Type, Poles	Induction motor, 2 poles, IP68	
	Lubrication	Turbine oil (ISO VG32)	
	Motor Protector (built-in)	Circle thermal cut-out, Miniature protector	
	Insulation	Insulation class B, Insulation class F	
	Phase / Voltage	3-phase / 400V / 50Hz / d.o.l., 3-phase / 400V / 50Hz / s.d.	
	Material	Casing	Grey iron casting EN-GJL-200
Shaft		Stainless steel EN-X30Cr13	
Cable		Rubber, H07RN-F, Rubber, NSSHÖU	
Discharge Connection		JIS 10K Flange, JIS 20K Flange	

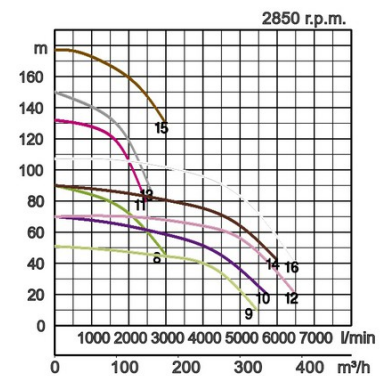
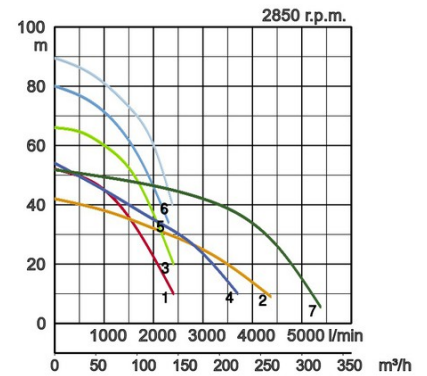

Dimensions in mm:

Model	d	A	B	B1	D	W1
LH615	150	7	1014	777	330	185
LH619	150	-	1352	1051	420	250
LH422	100	-	1352	1051	420	250
LH622	150	-	1352	1051	420	250
LH430	100	-	1352	1051	420	250
LH637	150	-	1448	1027	530	180
LH837	200	-	1488	1027	530	180
LH645	150	-	1448	1027	530	180
LH845	200	-	1488	1027	530	180
LH855	200	-	1716	1255	550	200
LH675	150	-	1676	1255	563	200
LH875	200	-	1716	1255	563	200
LH690	150	-	1787	1385	595	200
LH890	200	-	1787	1385	595	200
LH6110	150	-	1887	1485	592	200
LH8110	200	-	1887	1485	592	200

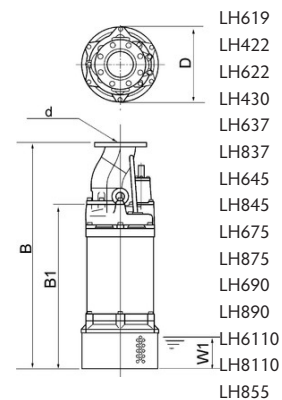
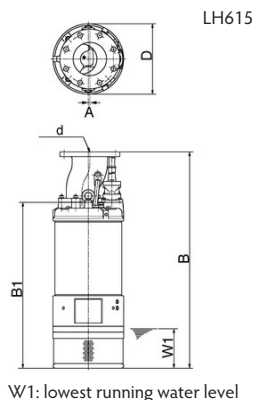

In the event of abrasive and corrosive utilization, stronger wear and tear will take place naturally in certain components. In this regard, please pay attention to our website www.tsurumi.eu/english/applications.htm.

Specifications:

Model	Colour code curve	Bore mm	Motor output kW	Rated current A	Head max. m	Capacity max. l/min	Dry weight kg w/o cable	Max. solid handling ø mm	Max. water depth m	Cable length m
GSZ-75-4	● 1	250	75,0	152,0	52,0	12500	1200	25	20	20
GSZ-75-4L	● 2	250	75,0	152,0	38,0	17500	1200	25	20	20

High Head Pumps - 4-pole motor for an increased lifetime



ø Discharge bore mm		250	
Pumping Fluid	Temperature	0-40°C	
	Type of Fluid	Spring water, Rain water, Ground water, Sand carrying water	
Pump	Components	Impeller	Closed type impeller
		Shaft Seal	Double mechanical seal
		Bearings	Shielded ball bearings
	Material	Impeller	Chromium iron casting
		Casing	Grey iron casting EN-GJL-200
Shaft Seal	Silicon carbide in oil bath		
Motor	Type, Poles	Induction motor, 4 poles, IP68	
	Lubrication	Turbine oil (ISO VG32)	
	Motor Protector (built-in)	Miniature protector	
	Insulation	Insulation class E	
	Phase / Voltage	3-phase / 400V / 50Hz / s.d.	
	Material	Casing	Grey iron casting EN-GJL-200
Shaft		Stainless steel EN-X30Cr13	
Cable		Rubber, H07RN-F, Rubber, NSSHÖU	
Discharge Connection		JIS 10K Flange	

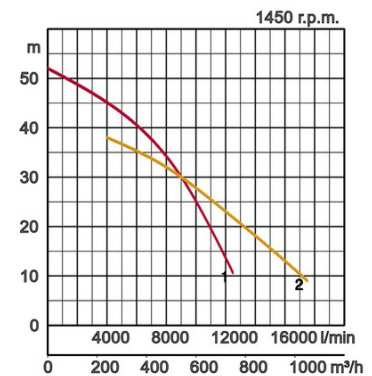

Dimensions in mm:

Model	d	A	A1	B1	D	H	W1
GSZ-75-4	250	1050	850	655	708	1733	510
GSZ-75-4L	250	1050	850	700	739	1778	730

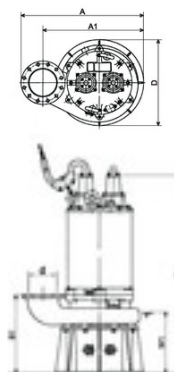

W1: lowest running water level

In the event of abrasive and corrosive utilization, stronger wear and tear will take place naturally in certain components. In this regard, please pay attention to our website www.tsurumi.eu/english/applications.htm.



Contributing to World-wide Prosperity and Understanding through Worker- and Environment-friendly Production.

Designed for increased productivity through fully integrated streamlined production systems, Tsurumi's factory in Kyoto (Japan) features a production capacity of a full 1 million pumps per year. Large-scale modern R&D facilities offer optimum conditions for experimenting and testing of even super-large pumps and for developing new products to expand the possibilities and applications of pumps. To provide optimum conditions for our main asset, our workers, as well as for the environment, special emphasis is placed on optimized working conditions with airconditioning, minimized dust and exhaust gas emission, comprehensive recycling and waste recovery.

Tsurumi (Europe) GmbH

Heltorfer Straße 14
D-40472 Düsseldorf
Tel.: +49 (0)211-4179373
Fax: +49 (0)211-4791429
Email: sales@tsurumi.eu
www.tsurumi.eu

We reserve the right to change specifications and designs herein for improvement without prior notice. Our pumps are for professional use only. In the event that Tsurumi (Europe) GmbH have, in exceptional cases taken over, a manufacturer's warranty, this entitles the enduser to assert remedy free of charge against Tsurumi (Europe) GmbH due to any defect to the product occurring during the guarantee period (see below), also then when the warranty claims against the seller do not or no longer exist. In the event of malfunction, which is attributable to the improper handling by the enduser, no guarantee claim shall arise. Further claims shall not result from the warranty, unless if something to the contrary has explicitly been determined. The decision as to whether remedy is effected by way of replacement or repair shall be at the choice of Tsurumi (Europe) GmbH. The claims shall be time barred after a period of three months after expiry of the guarantee period, however, not before expiry of the warranty period which is valid towards the seller. In the event of doubt, the warranty period shall correspond with the warranty period which is valid between the end-user and his seller.



1CON-EN

