



TSURUMI PUMP

LSC 1-phase
50Hz

Ideal for removal of residual water down to
1mm

- for professional use

Original residue dewatering pump capable of pumping down to floor level. Even the smallest puddle can be pumped dry. Ideal for complete drainage of flat surfaces where a sump is not available: rooftops, parking lots, garages, roadways, pools,...



Top Discharge

Pumped water flows between the outer cover and the motor, cooling the motor and discharging as illustrated (forced motor cooling). The pump can be run continuously in air.

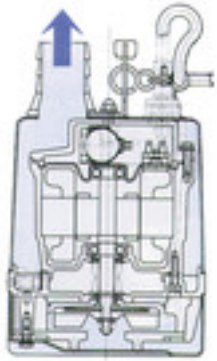

Features:

Double mechanical seal with lapped SiC rings in oil bath, as used in large heavy-duty pumps. When placed directly on a hard surface, strainer allows water to be removed down to 1mm. A peripheral diaphragm type check valve right above the strainer prevents loss of water when the pump is lifted or stopped. The pump's bottom plate has rubber all-around it, it cannot damage delicate surfaces.

Mit Niveauregler (Elektrode) lieferbar

Keine spezielle Installation erforderlich, sofort einsatzbereit.
Elektrode funktioniert selbst bei Verschmutzung einwandfrei.
Die Elektrode ist vollständig in Kunstharz eingegossen und durch ein Gummigehäuse geschützt.

Components:

001 Cable	050 Motor cover
020 Pump casing	051 Head cover
021 Impeller	052A Upper bearing
022 Suction plate	052B Lower bearing
023. Stand set	053. Miniature protector
025 Mechanical seal	054 Shaft
026 Oil sealing	055 Rotor
029 Oil casing	056 Stator
030 Oil lifter	064 Motor casing
031 Wear plate	065 Jacket
032 Hose coupling	068 Handle
035 Oil plug	071 Shaft sleeve
036 Lubricant	076 Condensor
049 Bottom plate	203. Check valve

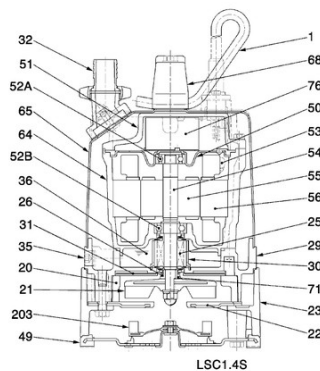

LSC1.4S

Specifications:

Model	Colour code curve	Bore mm	Motor output kW	Rated current A	Head max. m	Capacity max. l/min	Dry weight kg w/o cable	Max. solid handling ø mm	Max. water depth m	Cable length m
LSC1.4S	1	25	0,48	2,9	11,0	170	11,0	6	10	10
LSCE1.4S		25	0,48	2,9	11,0	170	11,0	6	10	10

ø Discharge bore mm		25	
Pumping Fluid	Temperature	0-40°C	
	Type of Fluid	Cleaning water, Water on floor, Puddles	
Pump	Components	Impeller	Semi-Vortex impeller
		Shaft Seal	Double mechanical seal
		Bearings	Shielded ball bearings
	Material	Impeller	Urethane rubber
		Casing	Ethylene propylene rubber
		Suction Plate	Steelplate+Urethane rubber
Shaft Seal	Silicon carbide in oil bath		
Motor	Type, Poles		Induction motor, 2 poles, IP68
	Lubrication		Turbine oil (ISO VG32)
	Motor Protector (built-in)		Miniature protector
	Insulation		Insulation class E
	Phase / Voltage		Single phase 230V / 110V / 50Hz
	Material	Casing	Aluminium die casting
		Shaft	Stainless steel EN-X6Cr13
Cable		Rubber, H07RN-F	
Discharge Connection		Hose coupling	

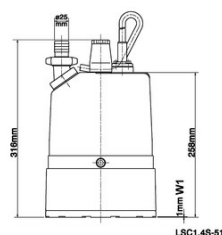
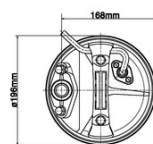
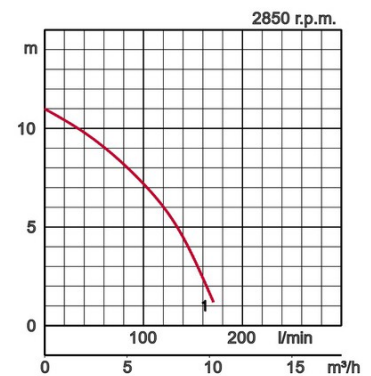

W1: lowest running water level

LSC1.4S

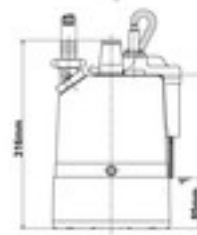
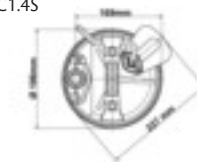

LSCE1.4S

In the event of abrasive and corrosive utilization, stronger wear and tear will take place naturally in certain components. In this regard, please pay attention to our website www.tsurumi.eu/english/applications.htm.



Contributing to World-wide Prosperity and Understanding through Worker- and Environment-friendly Production.

Designed for increased productivity through fully integrated streamlined production systems, Tsurumi's factory in Kyoto (Japan) features a production capacity of a full 1 million pumps per year. Large-scale modern R&D facilities offer optimum conditions for experimenting and testing of even super-large pumps and for developing new products to expand the possibilities and applications of pumps. To provide optimum conditions for our main asset, our workers, as well as for the environment, special emphasis is placed on optimized working conditions with airconditioning, minimized dust and exhaust gas emission, comprehensive recycling and waste recovery.

Tsurumi (Europe) GmbH

Heltorfer Straße 14
D-40472 Düsseldorf
Tel.: +49 (0)211-4179373
Fax: +49 (0)211-4791429
Email: sales@tsurumi.eu
www.tsurumi.eu

We reserve the right to change specifications and designs herein for improvement without prior notice. Our pumps are for professional use only. In the event that Tsurumi (Europe) GmbH have, in exceptional cases taken over, a manufacturer's warranty, this entitles the enduser to assert remedy free of charge against Tsurumi (Europe) GmbH due to any defect to the product occurring during the guarantee period (see below), also then when the warranty claims against the seller do not or no longer exist. In the event of malfunction, which is attributable to the improper handling by the enduser, no guarantee claim shall arise. Further claims shall not result from the warranty, unless if something to the contrary has explicitly been determined. The decision as to whether remedy is effected by way of replacement or repair shall be at the choice of Tsurumi (Europe) GmbH. The claims shall be time barred after a period of three months after expiry of the guarantee period, however, not before expiry of the warranty period which is valid towards the seller. In the event of doubt, the warranty period shall correspond with the warranty period which is valid between the end-user and his seller.



con-LSC-EN

